

SPECIFICATIONS

G12FF-4
G12FF-6
G12FF-8

Professional Freestanding Oven Range



G12FF-4



G12FF-6



G12FF-8

A synthesis of European design, ergonomics, and professional performance, the Kleenmaid Professional range of freestanding ovens offers freedom of choice with a range of made to order colour and cooktop options. The Kleenmaid professional range offers a variety of cooking capacities and multifunction programs to suit everyone from the largest family to the greatest entertainers. With custom design options, the Kleenmaid professional freestanding oven spoils even the most demanding chefs.

Features

- Oven Capacity: 96 litres (main oven)
37 litres (auxiliary oven)
- Programs: 9 multi-function programs - including rotisserie (main oven)
5 multi-function programs (auxiliary oven)
- Colour options: 11 made to order colour options
- Cooktop options: 11 cooktop options
- Dimensions: 1172mm (W) x 900 - 970*mm (H) x 623mm (D)
- *Cooker is 900mm high + feet adjustment 20mm. There is an optional cooker support accessory for purchase which adds another possible 50mm to the height.
- Accessories: SA-SZ12 cooker support & plinth
(optional) TSR03 telescopic guides
SK120 stainless steel splashback
K120 professional rangehood

10

10 Year Warranty*

For your nearest store call 13 13 08
www.kleenmaid.com.au

PROFESSIONAL

SPECIFICATIONS

Professional Freestanding Oven Range

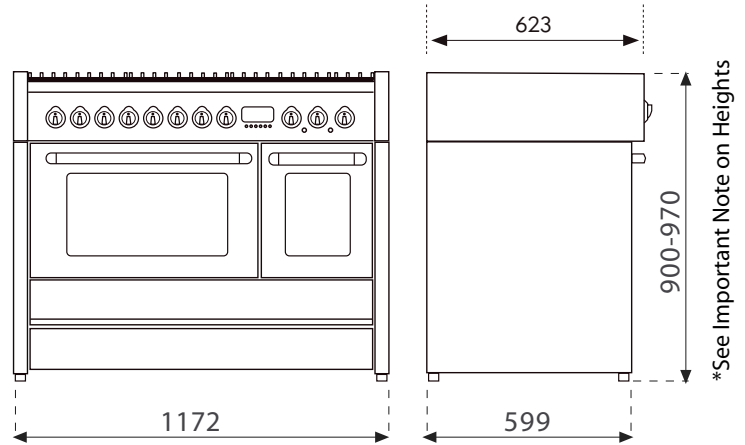
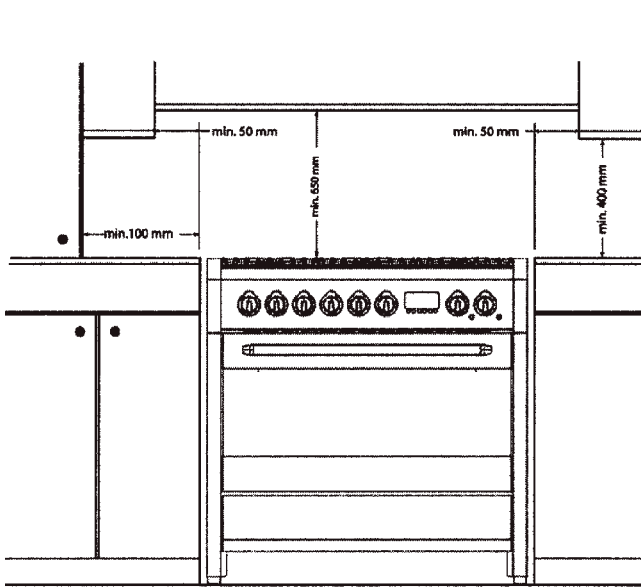

INSTALLATION

Ovens may be installed within the cupboard surrounds or at the end of the bench run. Non combustible material should be located behind the appliance when fitting. Required clearances around the gas cooktops (according to model) as per AS5601 - AG601 Gas Regulation (see Use and Care manual).

Height of Cooktop to Benchtop

Where the distance from the edge of any burner to a horizontal surface is **less than 200mm (*)** the surface must be either : 10mm (min) below the level of the hob, or have the vertical component of the surface suitably covered with a non-combustible material as specified in AS4501 (AG601). **ie. If less than 200mm (*) the cooktop can only be level with the benchtop if the benchtop is of non-combustible material.** Ensure your flex/pipe (gas connection) and cable (electrical connection) are not constricted or crushed. Make sure the gas connection fittings are easily accessible.

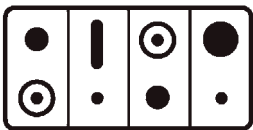

G12FF-8



G12FF-6T

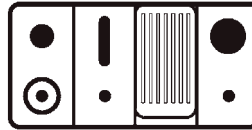

G12FF-6B

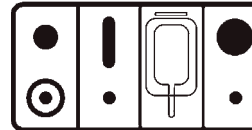

G12FF-6F

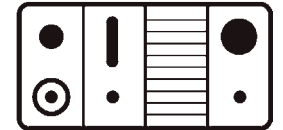

G12FF-6G



G12FF-6C

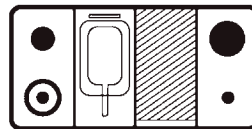

G12FF-4TF

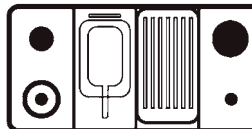

G12FF-4BF

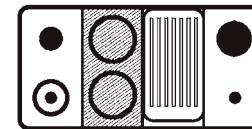

G12FF-4BC

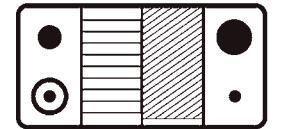

G12FF-4TG

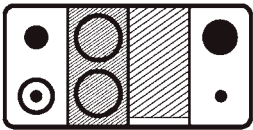

G12FF-4TC

IMPORTANT NOTE ON HEIGHTS: 900 - 970mm

Cooker is 900mm high + feet adjustment 20mm. There is an optional cooker support accessory for purchase which adds another possible 50mm to the height.

AGA Gas Approval No. 6404; Electrical Approval No. Q03102

Model	Capacity (Litres)	Gas Rating		Dimensions			Electrical Rating		
		kW	MJ	Width(mm)	Height(mm)	Depth (mm)	Voltage	kW	Amp
G12FF-8	96/37	17	62	1172	900 - 970	599	240	4.6	19
G12FF-6T	96/37	11.95	44	1172	900 - 970	599	240	7.0	30
G12FF-6B	96/37	11.95	44	1172	900 - 970	599	240	7.0	30
G12FF-6F	96/37	11.95	44	1172	900 - 970	599	240	6.8	30
G12FF-6G	96/37	11.95	44	1172	900 - 970	599	240	7.1	30
G12FF-6C	96/37	11.95	44	1172	900 - 970	599	240	7.0	30
G12FF-4TF	96/37	9.05	33	1172	900 - 970	599	240	9.2	38
G12FF-4BF	96/37	9.05	33	1172	900 - 970	599	240	9.2	38
G12FF-4BC	96/37	9.05	33	1172	900 - 970	599	240	9.4	39
G12FF-4TG	96/37	9.05	33	1172	900 - 970	599	240	9.5	40
G12FF-4TC	96/37	9.05	33	1172	900 - 970	599	240	9.4	39

*Technical Specifications and product sizes can be varied by Manufacturer without notice. Any cut-outs for appliances should only be by physical measurements. Drawings are not to scale. All information supplied is for general reference purposes only and is on the understanding that Kleenmaid Pty Ltd will not be liable for any loss, liability or damage whatsoever arising as a result of reliance of such information.